

8 Seiten

product catalogue 2017 p.o.s labeling system

- Made
- in
- Germany





S 2 label holder

bredel.de p.o.s

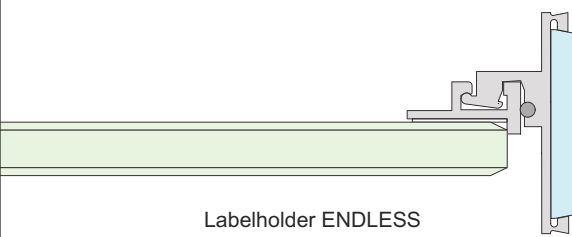

Labelholder ENDLESS

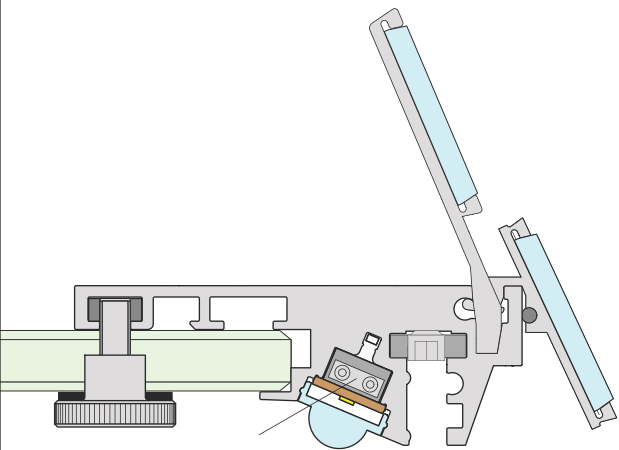
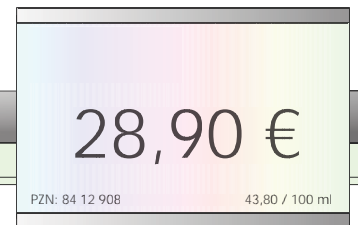
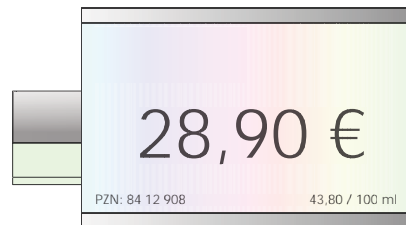

LED Lightning and labeling profil ENDLESS PRO

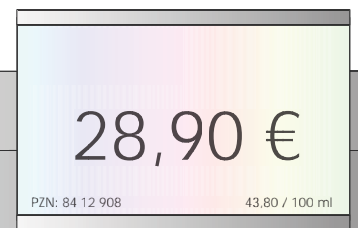

Labelholder ENDLESS,
1000 mm, with 3M adhesive tape,
cut on request, per unit

ASE 1000 16

19,90 €

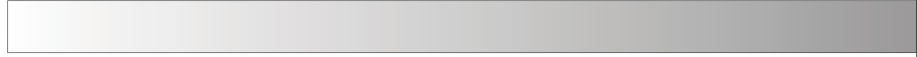
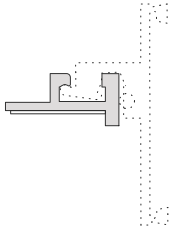

Labelholder 90°, 44 mm	EH 44 16 90	2,50 €
Labelholder 115°, 44 mm	EH 44 16 115	2,50 €
Labelholder 90°, 22 mm	EH 22 16 90	2,50 €
Labelholder 115°, 22 mm	EH 22 16 115	2,50 €

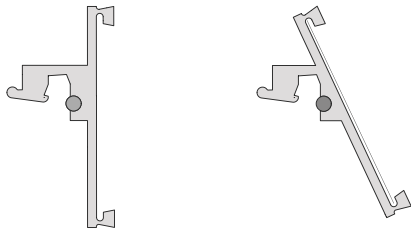

acrylic lens for label holder, 44 mm, per unit, sales unit of 20 pieces	AL 44 16	1,40 €
acrylic lens for label holder, 22 mm per unit, sales unit of 20 pieces	AL 22 16	1,40 €

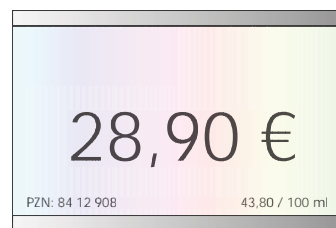
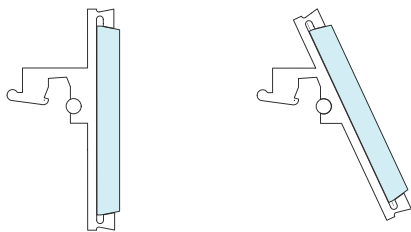

label holder logo 90°, 88 mm with lens
per unit, sales unit of 10 pieces

EHLL 88 16 90

8,90 €

label holder logo 115°, 88 mm with lens
per unit, sales unit of 10 pieces

EHLL 88 16 115

8,90 €

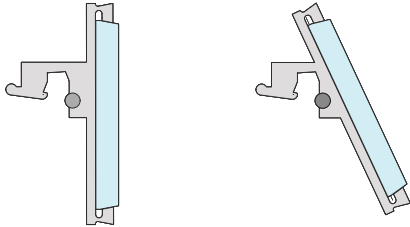

label holder high, 115°, 44 mm,

EHH 44 16 115

2,90 €

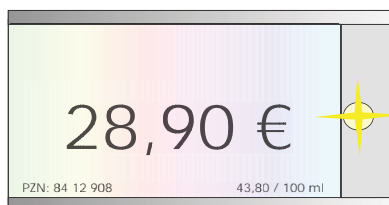
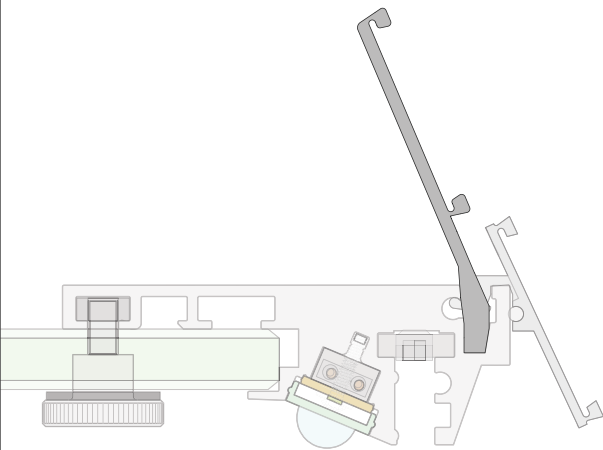

label holder high, logo, 115°, 88 mm milled,
with lens, per unit, sales unit of 10 pieces

EHLL 88 16 115

14,90 €

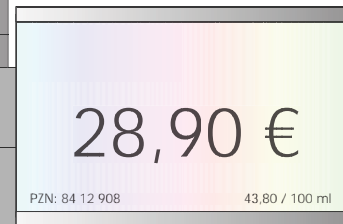
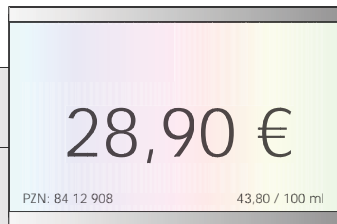

flashing module 55 mm red, with lens,
per unit, sales unit of 5 pieces

BMR 16

19,90 €

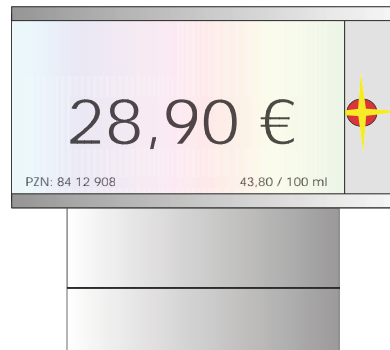
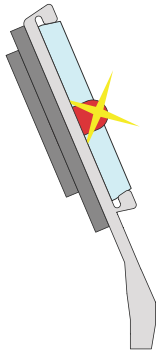

flashing module 55 mm white, with lens,
per unit, sales unit of 5 pieces

BMW 16

19,90 €

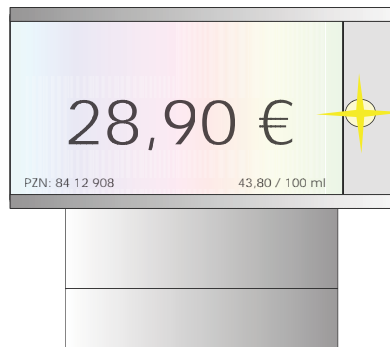
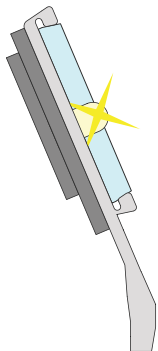

adaptor Flexiam, 43 mm , per unit, sales unit of 100 pieces

adaptor Flexiam 90°, 43 mm	AF 43 16 90	2,50 €
----------------------------	-------------	--------

adaptor Flexiam 115°, 43 mm	AF 43 16 115	2,50 €
-----------------------------	--------------	--------

adaptor Flexiam 90, 43 mm , per unit, sales unit of 50 pieces

adaptor Flexiam 90°, 21 mm	AF 21 16 90	2,50 €
----------------------------	-------------	--------

adaptor Flexiam 115°, 21 mm	AF 21 16 115	2,50 €
-----------------------------	--------------	--------

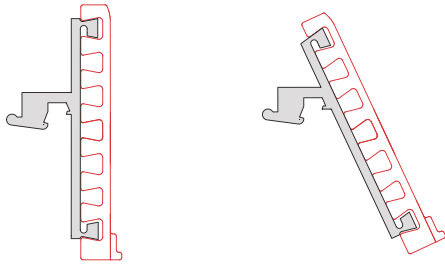

adaptor Taxom 115°, 48 mm, per unit, sales unit of 100 pieces

adaptor Taxom 115°, 48 mm	AT 48 16 115	2,50 €
---------------------------	--------------	--------

Adapter Taxom 115°, 24 mm	AT 24 16 115	2,50 €
---------------------------	--------------	--------

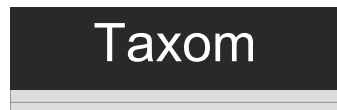
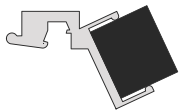

adaptor für Tronitag, per unit, sales unit of 100 pieces	AT 32 16 90	3,00 €
--	-------------	--------

adaptor für Tronitag, per unit, sales unit of 100 pieces	AT 32 16 115	3,00 €
--	--------------	--------

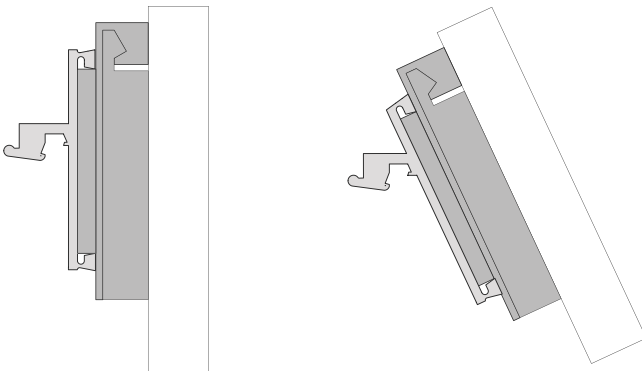

pendulum clip plastic for blister, per unit,
sales unit of 100 pieces

PC 1 16

0,50 €

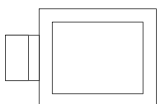

label holder high, longversion, 115°, 1000 mm
per unit, sales unit of 10 pieces

ESH 1000 16 115

30,90 €

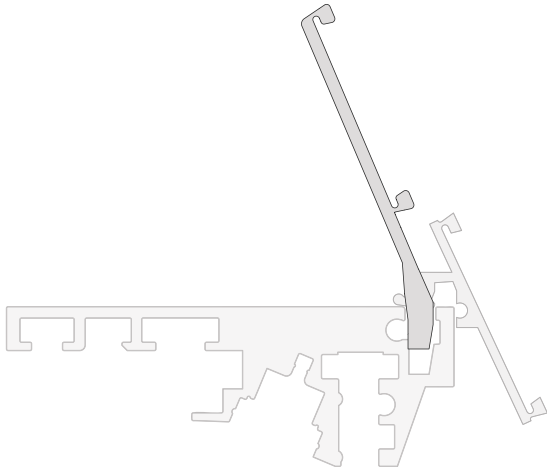

white foil strips, 1000 mm,
per unit, sales unit of 20 pieces

FSL 1000 16

3,90 €

